



18.025/2



18.025/4

VALVOLA DOPPIA DENSO JOHN DEERE 6081T - USE  
FOR DENSO INJECTOUR: 095000-055

VALVOLA DOPPIA DENSO JOHN DEERE 4045T - USE  
FOR DENSO INJECTOUR: 095000-650/872



18.026



18.026 P

KIT RITORNO INIETTORI DENSO UNA VIA

RACCORDO IN PLASTICA INIETTORI DENSO 1 VIA



18.027



18.027 P

KIT RITORNO INIETTORI DENSO DUE VIE

RACCORDO IN PLASTICA INIETTORI DENSO 2 VIE



**18.028**



**18.029**

RACCORDO DI MANDATA - Riferimento Originale:  
F.00R.J00.414 - BOSCH

RONDELLA DOPPIA Ø 8mm - Riferimento Originale:  
90904-30013 DENSO



**18.030**



**18.031**

RONDELLA DOPPIA Ø 12 mm

FILTRO RACCORDO INIETTORE DENSO

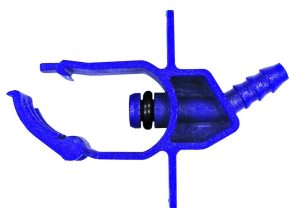

**18.033**



**18.034**

RITORNO INIETTORI DELPHI 1 VIA

RITORNO INIETTORI DELPHI 2 VIE FORD MONDEO



**18.034 /1**

RACCORDO IN PLASTICA INIETTORI FORD TRANSIT /  
MONDEO 1 VIA



**18.035**

RITORNO INIETTORI SIEMMENS



**18.035 P**

RITORNO INIETTORI SIEMENS IN PLASTICA



**18.036**

RITORNO INIETTORI SIEMMENS



**18.036 P**

RITORNO INIETTORI SIEMENS IN PLASTICA

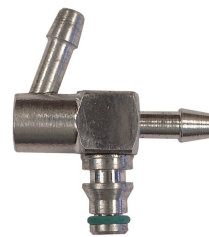

**18.037**

RITORNO INIETTORI SIEMMENS



18.038



18.039

CLIP RITORNO INIETTORI DENSO

RITORNO INIETTORI DENSO

18.040



18.041

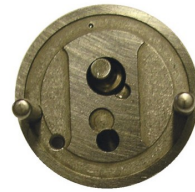

SEMISFERA DENSO INIETTORI

VALVOLA PIEZO ELETTRICO BOSCH

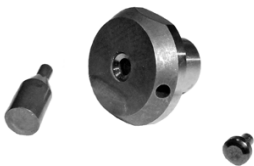

18.042

18.043



Kit valvola Piezo Siemens

Distanziale intermedio Siemens  $\varnothing$  14,2x5



**18.044**

Distanziale intermedio Siemens  $\varnothing$  14,2x5



**18.045**

VALVOLA DELPHI EUI - Codice Originale DELPHI 7207-0138



**18.046**

PISTONE GUIDA DELPHI EUI - Codice originale DELPHI 7027-0119



**18.047**

GRUPPO MOLLA DELPHI EUI - Codice Originale: DELPHI 7027-0017



**18.048**

KIT ADATTATORE DELPHI EUI - Codice Originale DELPHI 7135-487



**18.049**

Distanziale denso  $\varnothing$  15,3x8



**18.050**



**18.051**

Distanziale denso  $\varnothing$  16,3x8

Distanziale denso  $\varnothing$  16,3x8



**18.052**



**18.053**

Pistone con semisfera denso

Ghiera denso



**18.054**



**18.055**

Pistone con sfera denso

Ghiera denso



18.056

Punteria pompa CP4 - Riferimento originale:  
1.462.C24.999 Bosch



18.057

VALVOLA CAT C6/320D -Riferimento originale CAT  
32F61-00062



18.058

VALVOLA CAT C7



18.059

VALVOLA CAT C9



18.060

SOLENOIDE INIETTORE CAT C7-C9 HEUI



18.061

VITE PDE SIEMENS M6x88mm



**18.062**

BOCCOLA IN PLASTICA INIETTORI DENSO C.RAIL -  
Riferimento originale: 23256-27010 DENSO



**18.063**

BOCCOLA IN PLASTICA INIETTORI DENSO C.RAIL -  
Riferimento originale: 23256-27020 DENSO



**18.064**

BOCCOLA IN PLASTICA INIETTORI DENSO C.RAIL -  
Riferimento originale: 23256-30010 DENSO



**18.065**

PIASTRA DI REGISTRO BOSCH PDE 90/100 SPESSORE  
3,80mm



**18.066**

PIASTRA DI REGISTRO BOSCH PDE 90/100 SPESSORE  
3,82mm



**18.067**

PIASTRA DI REGISTRO BOSCH PDE 90/100 SPESSORE  
3,84mm





**18.069**

PIASTRA DI REGISTRO BOSCH PDE 90/100 SPESSORE 3,88mm



**18.070**

PIASTRA DI REGISTRO BOSCH PDE 90/100 SPESSORE 3,90mm



**18.071**

PIASTRA DI REGISTRO BOSCH PDE 90/100 SPESSORE 3,92mm



**18.072**

PIASTRA DI REGISTRO BOSCH PDE 90/100 SPESSORE 3,94mm



**18.073**

PIASTRA DI REGISTRO BOSCH PDE 90/100 SPESSORE 3,96mm



**18.074**

PIASTRA DI REGISTRO BOSCH PDE 90/100 SPESSORE 3,98mm



18.075

PIASTRA DI REGISTRO BOSCH PDE 90/100 SPESSORE 4,00mm



18.076

CLIP RECUPERO INIETTORI DENSO C.RAIL



18.077

VITE M3x30 DELPHI EUI

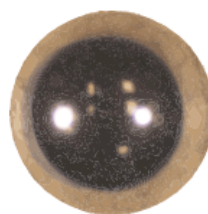

18.078

SFERA Ø 1,50mm - METALLO - Riferimento originale: F.00V.C05.010 BOSCH



18.079

VITE COPERCHIO ELETTROVALVOLA PLD BOSCH



18.080

PUNTERIA CP4 MODELLO CON FERMO - Riferimento originale: 1.462.C24.995 BOSCH

**18.081**



RACCORDO INIETTORI C/RAIL DELPHI 1 VIA

**18.082**



RACCORDO INIETTORI C/RAIL DELPHI 2 VIE

**18.083**



RACCORDO INIETTORE DENSO 095000-5800 / 1 VIA

**18.084**



RACCORDO INIETTORE DENSO 095000-5800 / 2 VIE

**18.085**



RACCORDO INIETTORE SIEMENS FORD / NISSAN / VOLVO / 1 VIA

**18.086**



RACCORDO INIETTORE SIEMENS FORD / NISSAN / VOLVO / 2 VIA



**18.068**

PIASTRA DI REGISTRO BOSCH PDE 90/100 SPESSORE  
3,86mm



**18.087**

RACCORDO INIETTORE FORD TRANSIT 1 VIA



**18.088**

RACCORDO INIETTORE FORD TRANSIT 2 VIE



**18.089**

RACCORDO VENTURI EURO4 / EURO 5



**18.091**

RACCORDO INIETTORE RENAULT MASTER 1 VIA



**18.092**

RACCORDO INIETTORE RENAULT MASTER 2 VIE



**18.093**

RACCORDO INIETTORE FORD / VOLVO / PEUGEOT 407



**18.094**

RACCORDO INIETTORE BOSCH PIEZO 1 VIA



**18.095**

RACCORDO INIETTORE SIEMENS 1 VIA



**18.096**

RACCORDO VENTURI 904 - Riferimento originale:  
9109-904 DELPHI



**18.097**

RACCORDO VENTURI 911 A - Riferimento originale:  
9109-911 A DELPHI



**18.098**

RACCORDO INIETTORE MERCEDES SPRINTER 1 VIA



**18.099**



**18.100**

RACCORDO INIETTORE MERCEDES SPRINTER 2 VIE

RACCORDO INIETTORE FORD FIESTA / CITROEN C3 - 1 VIA



**18.101**



**18.102**

RACCORDO INIETTORE FORD FIESTA / CITROEN C3 - 2 VIE

RACCORDO INIETTORE BOSCH 1 VIA



**18.103**



**18.104**

RACCORDO INIETTORE BOSCH 2 VIE

RACCORDO INIETTORE BOSCH PIEZO 1 VIA



**18.105**



**18.106**

RACCORDO INIETTORE BOSCH PIEZO 2 VIE

PARAPOLVERE INIETTORI C/RAIL BOSCH - Riferimento Originale: 1.609.848.080 BOSCH



**18.107**



**18.108**

PARAPOLVERE INIETTORI C/RAIL SIEMENS - AUDI - SEAT - SKODA - WV 1.6 TDI - Riferimento originale: 03L103070A SIEMENS

VALVOLA DENSO G4S - Riferimento originale: 295700 - .... DENSO

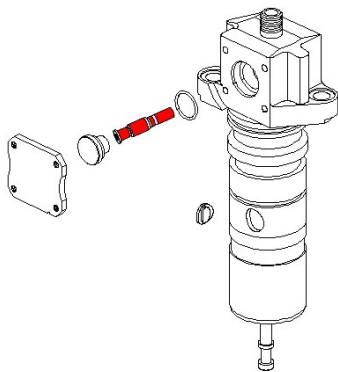

**6994**



**6995**

PISTONI VALVOLE PLD

PISTONE VALVOLA PLD - MISURA 6,995 mm



**7000**



**7005**

PISTONE VALVOLA PLD - MISURA 7,000 mm

PISTONE VALVOLA PLD - MISURA 7,005 mm



**7010**



**7015**

PISTONE VALVOLA PLD - MISURA 7,010 mm

PISTONE VALVOLA PLD - MISURA 7,015 mm



**7020**



**7025**

PISTONE VALVOLA PLD - MISURA 7,020 mm

PISTONE VALVOLA PLD - MISURA 7,025 mm





**14.605**

RACCORDO 90° ATTACCO RAPIDO RITORNO  
INIETTORI COMMON RAIL SIEMENS



**14.605 P**

RACCORDO 90° IN PLASTICA SIEMENS



**14.606**

RACCORDO A T CON ATTACCO RAPIDO RITORNO  
INIETTORI COMMON RAIL SIEMENS



**14.606 P**

RACCORDO A T IN PLASTICA SIEMENS



**14.608**

RACCORDO 90° CON ATTACCO RAPIDO RITORNO  
INIETTORI COMMON RAIL TIPO BOSCH



**14.608 P**

RACCORDO IN PLASTICA 90° RITORNO INIETTORE  
TIPO BOSCH



14.609



14.609 P

RACCORDO A T CON ATTACCO RAPIDO RITORNO INIETTORI COMMON RAIL TIPO BOSCH

RACCORDO IN PLASTICA T RITORNO INIETTORI TIPO BOSCH



18.090



18.001

RACCORDO INIETTORE FORD TRANSIT 1 VIA

FERMO RITORNO INIETTORI COMMON RAIL SIEMMENS Riferimento Originale: X11-800-001-001 SIEMMENS



18.002



18.003

FERMO RITORNO INIETTORI COMMON RAIL SIEMMENS - Riferimento Originale: X11-800-001-002Z SIEMMENS

FERMO RITORNO INIETTORI COMMON RAIL SIEMMENS - Riferimento Originale: X11-800-001-003Z SIEMMENS



**18.004**

SFERA Ø 1,34mm - METALLO PER INIETTORI TIPO BOSCH - Riferimento Originale: F.00V.C05.001 BOSCH



**18.005**

RONDELLA ACCIAIO BASE RACCORDO ENTRATA INIETTORI 6x10x1mm - Riferimento Originale: F.00V.C17.002 BOSCH



**18.006**

GUARNIZIONE TEFLON/BRONZO INIETTORI TIPO BOSCH - Riferimento Originale: F.00V.C04.049 BOSCH



**18.007**

RONDELLA BASE 8x10x0,25 - Riferimento Originale: F.00V.C17.105 BOSCH



**18.008**

RACCORDO ENTRATA POMPE CP1 M12x1,5/M12x1 - Riferimento Originale: F.00R.0P0.471 BOSCH

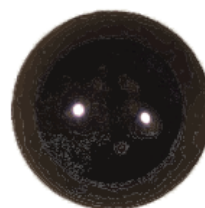

**18.009**

SFERA Ø 1,34 mm IN MATERIALE CERAMICO - Riferimento Originale: F.00V.C05.006 BOSCH



**18.010**

RACCORDO ENTRATA INIETTORI M12x1,5/M12X1,5 -  
Riferimento Originale: F.00V.C16.009 BOSCH

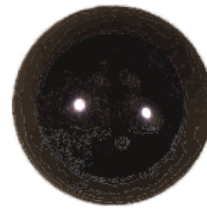

**18.011**

SFERA Ø 1,50 mm IN MATERIALE CERAMICO -  
Riferimento Originale: F.00V.C05.008 BOSCH



**18.012**

RACCORDO IN OTTONE CP1 - Riferimento Originale:  
F.01M.100.473 BOSCH



**18.013**

RACCORDO IN OTTONE CP1 - Riferimento Originale:  
F.00R.0P0.623 BOSCH



**18.014**

RACCORDO IN OTTONE CP1 - Riferimento Originale:  
F.01M.100.476 BOSCH

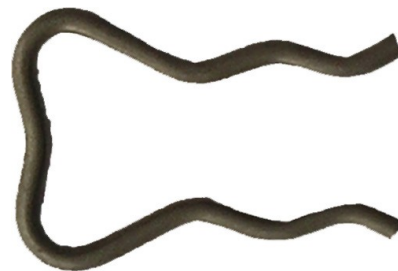

**18.015**

FERMO RITORNO INIETTORI TIPO BOSCH - Riferimento  
Originale: F.00V.C22.003 BOSCH

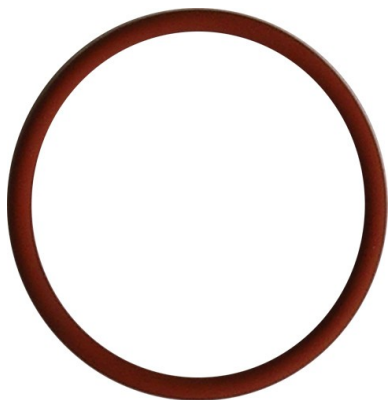

18.016

ORING GHIERA INIETTORE 21x1,5 VITON - Riferimento Originale: F.00V.C38.002 BOSCH

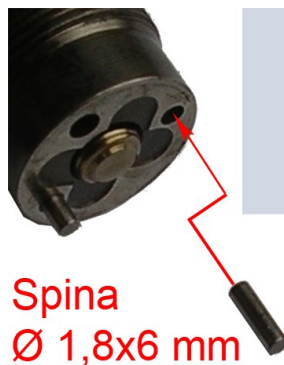

Spina  
Ø 1,8x6 mm

18.017

SPINA Ø 1,8x6 mm INIETTORE - Riferimento Originale: 2.433.201.024 BOSCH



18.018

GUIDA SFERA INIETTORE - Riferimento Originale: F.00V.C21.001 BOSCH



18.019

FERMO BLOCCO MOLLE INIETTORE - Riferimento Originale: F.00Z.C99.007 BOSCH



18.020

VITE BLOCCAGGIO INIETTORI MERCEDES



18.021

CONNETTORE INIETTORI TIPO MERCEDES



18.022

CONNETTORE INIETTORI TIPO BOSCH



18.023

PARAOLIO POMPA DELPHI COMMON RAIL 20x32x6 mm - Riferimento Originale: 9307-412A DELPHI



18.024/01

VALVOLA DENSO CITROEN/FIAT/PEUGEOT - USE FOR DENSO INJECTOUR: 095000-580



18.024/02

VALVOLA DENSO TOYOTA USE FOR DENSO INJECTOUR: 095000-604/623/691/728/764



18.024/03

VALVOLA DENSO MITSUBISHI - USE FOR DENSO INJECTOUR: 095000-576



18.024/04

VALVOLA DENSO HINO/KOBELCO/MAZDA/  
SUBARU/LIUGONG/SHANTUI/HUNDAY USE FOR  
DENSO INJECTOUR:  
095000-503/522/555/635/659/679/785/789/831



**18.024/05**

VALVOLA DENSO TOYOTA - USE FOR DENSO  
INJECTOUR:  
095000-552/574/589/592/593/619/652/676/677/687/7  
03/704/736/739/741/743/773/775/776/778/780/829/8  
74



**18.024/06**

VALVOLA DENSO ISUZU - USE FOR DENSO  
INJECTOUR: 095000-547/551/665/890



**18.024/07**

VALVOLA DENSO MAZDA /TOYOTA - USE FOR DENSO  
INJECTOUR: 295050-001/081



**18.024/08**

VALVOLA DENSO D-MAX/NISSAN/  
OPEL/RENAULT/SAAB/TOYOTA - USE FOR DENSO  
INJECTOUR:  
095000-513/518/583/602/624/652/698/977



**18.024/09**

VALVOLA DENSO TOYOTA - USE FOR DENSO  
INJECTOUR: 095000  
512/542/641/689/696/722/731/758/767



**18.024/10**

VALVOLA DENSO NISSAN - USE FOR DENSO  
INJECTOUR: 095000-565/625



**18.024/11**

VALVOLA DENSO ISUZU - USE FOR DENSO  
INJECTOUR: 095000-534/636



**18.024/12**

VALVOLA DENSO HINO - USE FOR DENSO INJECTOUR:  
095000-52



**18.024/13**

VALVOLA DENSO SINOTRUCK - USE FOR DENSO  
INJECTOUR: 095000-670/801/810



**18.024/14**

VALVOLA DENSO DONGFENG - USE FOR DENSO  
INJECTOUR: 095000-622



**18.024/15**

VALVOLA DENSO FORD/MAZDA - USE FOR DENSO  
INJECTOUR: 095000-578/706



**18.024/16**

VALVOLA DENSO OPEL - USE FOR DENSO INJECTOUR:  
095000-613





**18.024/17**

**18.024/18**



VALVOLA DENSO TOYOTA - USE FOR DENSO  
INJECTOUR: 095000-668/697/733/769

VALVOLA DENSO MITSUBISHI - USE FOR DENSO  
INJECTOUR: 095000-560



**18.024/19**

**18.024/20**



VALVOLA DENSO TOYOTA - USE FOR DENSO  
INJECTOUR: 095000-561/611/690/725/761

VALVOLA DENSO OPEL - USE FOR DENSO INJECTOUR:  
095000-508



**18.025/1**

VALVOLA DOPPIA DENSO  
NISSAN/OPEL/RENAULT/SAAB/TOYOTA USE FOR  
DENSO INJECTOUR: 095000-036  
/042/043/052/053/057/063/064/074/075/077/088/094/  
095